

Saint-Gobain Isover UK Limited

Whitehouse Industrial Estate
Runcorn
Cheshire WA7 3DP

Tel: 0800 032 2555

e-mail: isover.enquiries@saint-gobain.com

website: www.isover.co.uk



Agrément Certificate

18/5560

Product Sheet 2

ISOVER CAVITY WALL INSULATION

CWS 36, CWS 34 AND CWS 32 FOR PARTIAL FILL

This Agrément Certificate Products Sheet⁽¹⁾ relates to CWS 36, CWS 34 and CWS 32 for Partial Fill, unfaced glass mineral wool slabs for use as partial fill thermal insulation in new external masonry cavity walls, without height restriction (additional requirements apply for buildings above 25 metres), in new buildings of a domestic and non-domestic nature. The products are installed during construction.

(1) Hereinafter referred to as 'Certificate'.

CERTIFICATION INCLUDES:

- factors relating to compliance with Building Regulations where applicable
- factors relating to additional non-regulatory information where applicable
- independently verified technical specification
- assessment criteria and technical investigations
- design considerations
- installation guidance
- regular surveillance of production
- formal three-yearly review.

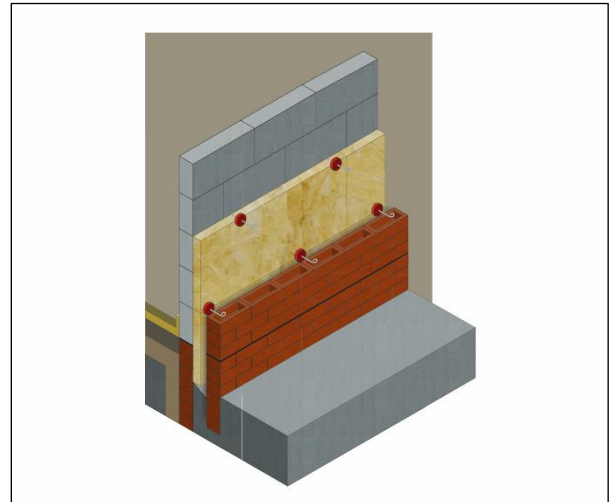

KEY FACTORS ASSESSED

Thermal performance — the products have declared thermal conductivities (λ_D) of $0.036 \text{ W}\cdot\text{m}^{-1}\cdot\text{K}^{-1}$ for CWS 36, $0.034 \text{ W}\cdot\text{m}^{-1}\cdot\text{K}^{-1}$ for CWS 34 and $0.032 \text{ W}\cdot\text{m}^{-1}\cdot\text{K}^{-1}$ for CWS 32 (see section 6).

Water resistance — the products will resist the transfer of water across the cavity (see section 7).

Condensation risk — the products can contribute to limiting the risk of condensation (see section 8).

Behaviour in relation to fire — the products have a reaction to fire classification of Class A1 to BS EN 13501-1 : 2007 (see section 9).

Durability — the products are durable, rot proof, water resistant and sufficiently stable to remain effective as insulation for the life of the building (see section 11).

The BBA has awarded this Certificate to the company named above for the products described herein. These products have been assessed by the BBA as being fit for their intended use provided they are installed, used and maintained as set out in this Certificate.

On behalf of the British Board of Agrément

Date of First issue: 23 August 2018

John Albon – Head of Approvals
Construction Products

Claire Curtis-Thomas
Chief Executive

The BBA is a UKAS accredited certification body – Number 113.

The schedule of the current scope of accreditation for products certification is available in pdf format via the UKAS link on the BBA website at www.bbacerts.co.uk

Readers are advised to check the validity and latest issue number of this Agrément Certificate by either referring to the BBA website or contacting the BBA direct.

Any photographs are for illustrative purposes only, do not constitute advice and should not be relied upon.

British Board of Agrément

Bucknalls Lane
Watford
Herts WD25 9BA

©2018

tel: 01923 665300
clientservices@bbacerts.co.uk
www.bbacerts.co.uk

Regulations

In the opinion of the BBA, CWS 36, CWS 34 and CWS 32 for Partial Fill, if installed, used and maintained in accordance with this Certificate, can satisfy or contribute to satisfying the relevant requirements of the following Building Regulations (the presence of a UK map indicates that the subject is related to the Building Regulations in the region or regions of the UK depicted):



The Building Regulations 2010 (England and Wales) (as amended)

Requirement:	B3(4)	Internal fire spread (structure)
Comment:		The products can contribute to satisfying this Requirement. See section 9 of this Certificate.
Requirement:	C2(a)	Resistance to moisture
Comment:		The products can contribute to satisfying this Requirement. See section 7.1 of this Certificate.
Requirement:	C2(b)	Resistance to moisture
Comment:		The products can contribute to satisfying this Requirement. See section 7.2 of this Certificate.
Requirement:	C2(c)	Resistance to moisture
Comment:		The products can contribute to satisfying this Requirement. See sections 8.1 and 8.4 of this Certificate.
Requirement:	L1(a)(i)	Conservation of fuel and power
Comment:		The products can contribute to satisfying this Requirement. See section 6 of this Certificate.
Regulation:	7	Materials and workmanship
Comment:		The products are an acceptable material. See section 11 and the <i>Installation</i> part of this Certificate.
Regulation:	26	CO₂ emission rates for new buildings
Regulation:	26A	Fabric energy efficiency rates for new dwellings (applicable to England only)
Regulation:	26A	Primary energy consumption rates for new buildings (applicable to Wales only)
Regulation:	26B	Fabric performance values for new dwellings (applicable to Wales only)
Comment:		The products can contribute to satisfying these Regulations. See section 6 of this Certificate.



The Building (Scotland) Regulations 2004 (as amended)

Regulation:	8(1)	Durability, workmanship and fitness of materials
Comment:		The products can contribute to a construction satisfying this Regulation. See section 11 and the <i>Installation</i> part of this Certificate.
Regulation:	9	Building standards applicable to construction
Standard:	2.4	Cavities
Comment:		The products can contribute to a construction satisfying this Standard, with reference to clause 2.4.2 ⁽¹⁾⁽²⁾ . See section 9 of this Certificate.
Standard:	2.6	Spread to neighbouring buildings
Comment:		The products are non-combustible and can contribute to satisfying the requirements of this Standard, with reference to clauses 2.6.5 ⁽¹⁾ and 2.6.6 ⁽²⁾ . See section 9 of this Certificate.
Standard:	3.4	Moisture from the ground
Comment:		The products can contribute to a construction satisfying this Standard, with reference to clauses 3.4.1 ⁽¹⁾⁽²⁾ and 3.4.5 ⁽¹⁾⁽²⁾ . See section 7.1 of this Certificate.

Standard:	3.10	Precipitation
Comment:		The products can contribute to satisfying this Standard, with reference to clauses 3.10.1 ⁽¹⁾⁽²⁾ and 3.10.3 ⁽¹⁾⁽²⁾ provided it complies with the conditions in section 7.2 of this Certificate.
Standard:	3.15	Condensation
Comment:		The products can contribute to satisfying this Standard, with reference to clauses 3.15.1 ⁽¹⁾⁽²⁾ , 3.15.4 ⁽¹⁾⁽²⁾ and 3.15.5 ⁽¹⁾⁽²⁾ . See sections 8.1 and 8.5 of this Certificate.
Standard:	6.1(b)	Carbon dioxide emissions
Standard:	6.2	Building insulation envelope
Comment:		The products can contribute to satisfying clauses, or parts of, 6.1.1 ⁽¹⁾ , 6.1.2 ⁽²⁾ , 6.1.6 ⁽¹⁾ , 6.2.1 ⁽¹⁾⁽²⁾ , 6.2.3 ⁽¹⁾ , 6.2.4 ⁽²⁾ , 6.2.5 ⁽²⁾ , 6.2.9 ⁽¹⁾ 6.2.10 ⁽¹⁾ , 6.2.11 ⁽²⁾ and 6.2.13 ⁽²⁾ of these Standards. See section 6 of this Certificate.
Standard:	7.1(a)(b)	Statement of sustainability
Comment:		The products can contribute to satisfying the relevant requirements of Regulation 9, Standards 1 to 6, and therefore will contribute to a construction meeting a bronze level of sustainability as defined in this Standard. In addition, the products can contribute to a construction meeting a higher level of sustainability as defined in this Standard, with reference to clauses 7.1.4 ⁽¹⁾⁽²⁾ [Aspects 1 ⁽¹⁾⁽²⁾ and 2 ⁽¹⁾], 7.1.6 ⁽¹⁾⁽²⁾ [Aspects 1 ⁽¹⁾⁽²⁾ and 2 ⁽¹⁾] and 7.1.7 ⁽¹⁾⁽²⁾ [Aspect 1 ⁽¹⁾⁽²⁾]. See section 6 of this Certificate.
Regulation:	12	Building standards applicable to conversions
Comment:		All comments given for the products under Regulation 9, Standards 1 to 6, also apply to this Regulation, with reference to clause 0.12.1 ⁽¹⁾⁽²⁾ and Schedule 6 ⁽¹⁾⁽²⁾ .
		(1) Technical Handbook (Domestic). (2) Technical Handbook (Non-Domestic).



The Building Regulations (Northern Ireland) 2012 (as amended)

Regulation:	23	Fitness of materials and workmanship
Comment:		The products are an acceptable material. See section 11 and the <i>Installation</i> part of this Certificate.
Regulation:	28(a)	Resistance to moisture and weather
Comment:		The products can contribute to a construction satisfying this Regulation. See section 7.1 of this Certificate.
Regulation:	28(b)	Resistance to moisture and weather
Comment:		The products can contribute to satisfying this Regulation. See section 7.2 of this Certificate.
Regulation:	29	Condensation
Comment:		The products can contribute to satisfying this Regulation. See section 8.1 of this Certificate.
Regulation:	35(4)	Internal fire spread – structure
Comment:		The products can contribute to satisfying this Regulation. See section 9 of this Certificate.
Regulation:	39(a)(i)	Conservation measures
Regulation:	40(2)	Target carbon dioxide emission rate
Comment:		The products can contribute to satisfying these Regulations. See section 6 of this Certificate.

Construction (Design and Management) Regulations 2015

Construction (Design and Management) Regulations (Northern Ireland) 2016

Information in this Certificate may assist the client, designer (including Principal Designer) and contractor (including Principal Contractor) to address their obligations under these Regulations.

See section: 3 *Delivery and site handling* (3.3) of this Certificate.

Additional Information

NHBC Standards 2018

In the opinion of the BBA, CWS 36, CWS 34 and CWS 32 for Partial Fill, if installed, used and maintained in accordance with this Certificate, can satisfy or contribute to satisfying the relevant requirements in relation to *NHBC Standards*, Chapter 6.1 *External masonry walls*.

CE marking

The Certificate holder has taken the responsibility of CE marking the products in accordance with harmonised European Standard BS EN 13162 : 2012. An asterisk (*) appearing in this Certificate indicates that data shown are given in the manufacturer's Declaration of Performance.

Technical Specification

1 Description

CWS 36, CWS 34 and CWS 32 for Partial Fill consist of layers of bonded, water-repellent-treated glass wool, formed into resilient slabs using a resin binder, with the nominal characteristics given in Table 1.

Table 1 Nominal characteristics

Characteristic (unit)	CWS 36	CWS 34	CWS 32
Length (mm)	1200	1200	1200
Width (mm)	455	455	455
Thickness (mm)	50, 65, 75, 85, 100, 125, 150	75, 100, 125, 150	65, 75, 85, 100, 125, 150

2 Manufacture

2.1 Raw materials, mixed to a controlled formulation, are melted in a furnace to produce molten glass. Glass fibres are produced from the molten glass using a rotary spinning process. The fibres are treated with a resin and formed into a continuous length of insulation to the required thickness. The insulation then passes into an oven which cures the resin. The insulation is then cut to the required dimensions to form the slabs.

2.2 As part of the assessment and ongoing surveillance of product quality, the BBA has:

- agreed with the manufacturer the quality control procedures and products testing to be undertaken
- assessed and agreed the quality control operated over batches of incoming materials
- monitored the production process and verified that it is in accordance with the documented process
- evaluated the process for management of nonconformities
- checked that equipment has been properly tested and calibrated
- undertaken to carry out the above measures on a regular basis through a surveillance process, to verify that the specifications and quality control operated by the manufacturer are being maintained.

2.3 The management system of the manufacturer has been assessed and registered as meeting the requirements of ISO 9001 : 2015 and ISO 14001 : 2015 by BSI (Certificates FM 674646 and EMS 674645 respectively).

3 Delivery and site handling

3.1 The slabs are delivered to site in polythene-wrapped packs. Each pack contains a label bearing the manufacturer's name, board dimensions and the BBA logo incorporating the number of this Certificate.

3.2 The slabs should be stored clear of the ground, on a clean level surface and preferably under cover to protect them from prolonged exposure to moisture or mechanical damage.

3.3 It is recommended that dust masks, gloves and long-sleeved clothing are worn during the cutting and handling of the products.

3.4 Damaged, contaminated or wet products must not be used.

Assessment and Technical Investigations

The following is a summary of the assessment and technical investigations carried out on CWS 36, CWS 34 and CWS 32 for Partial Fill.

Design Considerations

4 Use

4.1 CWS 36, CWS 34 and CWS 32 for Partial Fill are satisfactory for use as partial fill cavity wall insulation and are used to reduce the thermal transmittance (U value) of external cavity walls with masonry inner and outer leaves (where masonry includes clay and calcium silicate bricks, concrete blocks, and natural and reconstituted stone blocks). The products are for use in new domestic and non-domestic buildings without height restriction (additional requirements apply above 25m). It is essential that walls are designed and constructed to incorporate the precautions given in this Certificate to prevent moisture penetration.

4.2 Two layers of slabs can also be installed if necessary in order to achieve the required U values (see section 6.2). In this case, vertical joints between the outer slabs must be staggered to those of the inner slabs.

4.3 As with other forms of cavity wall insulation, where buildings need to comply with *NHBC Standards 2018*, specifiers should observe the requirements of that document.

4.4 Buildings subject to the national Building Regulations should be constructed in accordance with the relevant recommendations of:

- BS EN 1996-1-1 : 2005, BS EN 1996-1-2 : 2005, BS EN 1996-2 : 2006 and BS EN 1996-3 : 2006, and their UK National Annexes
- BS EN 845-1 : 2013 and BS 8000-3 : 2001.

4.5 New buildings not subject to regulatory requirements should also be built in accordance with the Standards identified in section 4.4.

4.6 Cavity wall ties and, if required, any additional ties to BS EN 845-1 : 2013 and PD 6697 : 2010 should be used for structural stability in accordance with BS EN 1996-1-1 : 2005, BS EN 1996-2 : 2006 and BS EN 1996-3 : 2006.

4.7 Care must be taken in the overall design and construction of walls incorporating the products to ensure the provision of appropriate:

- cavity trays and damp-proof courses (dpc's)
- cavity barriers and fire dampers
- resistance to the ingress of precipitation, moisture and dangerous gases from the ground
- resistance to sound transmission when flanking separating walls and floors.

4.8 The use of cavity battens or boards is strongly recommended to prevent thermal bridging by mortar droppings.

Buildings up to and including 25 metres high

4.9 The residual cavity width to be maintained during construction is 50 mm. This may reduce to 25 mm in isolated areas due to individual construction features (a minimum of 50 mm residual cavity width is required by the NHBC). This may be achieved by designing a cavity width which takes into account the dimensional tolerances of the components which make up the wall (by reference to the British Standards relating to the bricks, blocks and slabs), or by using the data from the respective manufacturers. Allowances may need to be made for the quality of building operatives and the degree of site supervision or control available, and for the limitations in respect of exposure of the proposed building (as set out in Table 2).

Table 2 Maximum allowable total exposure factors of different constructions

Construction	Maximum allowable exposure factor $E^{(1)}$
All external masonry walls protected by: rendering (to BS EN 13914-1 : 2016), tile/slate hanging or timber, plastic or metal weatherboarding or cladding	No restriction
One or more external masonry walls constructed from facing clay brickwork or natural stone (the porosity of which exceeds 20% by volume). Mortar joints must be flush-pointed or weatherstruck	100
One or more external masonry walls constructed from calcium silicate bricks, concrete blocks, reconstituted stone, or natural stone (the porosity of which is less than 20% by volume), or any material with raked mortar joints	88

1) To BS 5618 : 1985.

4.10 From ground level, the maximum height of continuous cavity walls must not exceed 12 metres; above 12 metres, the maximum height of continuous cavity walls must not exceed 7 metres. In both cases, breaks should be in the form of continuous horizontal cavity trays and weepholes discharging to the outside.

4.11 An external render coat or other suitable finish should be applied in locations where such application would be normal practice; care should be taken to ensure that the residual cavity is not bridged by mortar.

Buildings over 25 metres in height

4.12 The width of the residual clear cavity to be achieved is to be a minimum of 50 mm, and the following additional requirements apply:

- the specifier must take extra care when detailing to ensure that the introduction of the insulation does not affect the weather resistance of the wall. Above average site supervision is recommended during installation of the products
- where, for structural reasons, the cavity width is reduced, eg by the intrusion of ring beams, a minimum residual cavity width of 25 mm must be maintained and extra care must be taken with fixings and weatherproofing, eg the inclusion of cavity trays with weepholes.

5 Practicability of installation

The products are designed to be installed by a competent general builder, or a contractor, experienced with these types of products.

6 Thermal performance



6.1 Calculations of the thermal transmittance (U value) of specific external wall constructions should be carried out in accordance with BS EN ISO 6946 : 2017 and BRE Report BR 443 : 2006, using the declared thermal conductivities (λ_D)* given in Table 3.

Table 3 Thermal conductivity (λ_D) values of the insulation

Insulation	Thermal conductivity ($W \cdot m^{-1} \cdot K^{-1}$)
CWS 36	0.036*
CWS 34	0.034*
CWS 32	0.032*

6.2 The U value of a completed wall will depend on the insulation type and thickness, number and type of fixings, the insulating value of the substrate masonry and its internal finish. Calculated U values for example constructions are given in Table 4.

Table 4 Example U values⁽¹⁾

U value requirement ($W \cdot m^{-2} \cdot K^{-1}$)	Insulation thickness (mm)					
	100 mm dense block ⁽²⁾ 13 mm dense plaster ⁽³⁾			100 mm AAC block ⁽⁴⁾ Plasterboard on dabs ⁽⁵⁾		
	CWS 36	CWS 34	CWS 32	CWS 36	CWS 34	CWS 32
0.18	185 ⁽⁶⁾	170 ⁽⁶⁾	160 ⁽⁶⁾	150	150	150
0.19	170 ⁽⁶⁾	160 ⁽⁶⁾	150	150	150	125
0.25	125	125	125	100	100	85
0.26	125	125	125	100	100	85
0.27	125	125	100	85	100	85
0.28	125	125	100	85	75	75
0.30	100	100	100	75	75	75
0.35	85	100	75	65	75	75

(1) Assumes fixings correction for fully penetrating steel fixings ($17 W \cdot m^{-1} \cdot K^{-1}$) at $2.5 m^2$ with cross-sectional area of $12.5 mm^2$. Construction includes 102.5 mm thick brick outer leaf.

(2) Dense block and mortar thermal conductivity 1.13 and $0.88 W \cdot m^{-1} \cdot K^{-1}$ respectively.

(3) Plaster thermal conductivity $0.57 W \cdot m^{-1} \cdot K^{-1}$.

(4) AAC block and mortar thermal conductivity 0.12 and $0.88 W \cdot m^{-1} \cdot K^{-1}$ respectively.

(5) Plasterboard thermal conductivity $0.25 W \cdot m^{-1} \cdot K^{-1}$.

(6) Made up of two layers of the same insulation product using the available thicknesses from Table 1.

Junctions



6.3 The products can contribute to maintaining continuity of thermal insulation at junctions with other elements and minimise thermal bridges and air infiltration. Detailed guidance can be found in the documents supporting the national Building Regulations. Advice can also be sought from the Certificate holder.

7 Water resistance



7.1 The products may be used in situations where they bridge the dpc in walls; dampness from the ground will not pass through to the inner leaf provided the wall is detailed in accordance with the requirements and provisions of the national Building Regulations.

7.2 Constructions incorporating the products and built in accordance with the Standards listed in section 4.5, will resist the transfer of precipitation to the inner leaf and satisfy the national Building Regulations.

7.3 In all situations, it is particularly important to ensure during installation that:

- installation is carried out to the highest level on each wall, or the top edge of the insulation is protected by a cavity tray
- cavity trays are used with appropriate stop ends and weep holes at lintel level
- cavity battens and/or boards are used during construction to prevent bridging by mortar droppings
- wall ties are installed correctly and are thoroughly clean
- excess mortar is cleaned from the cavity face of the leading leaf and any debris removed from the cavity
- mortar droppings are cleaned from the exposed edges of installed slabs
- dpc's at ground level do not project into the cavity as they can form a trap for mortar bridging

- insulation slabs are properly installed and butt-jointed
- raked or recessed mortar joints are avoided in very severe exposure areas.

7.4 Window and door opening reveals should be constructed incorporating a cavity barrier/closer/dpc, as required.

8 Condensation risk

Interstitial condensation



8.1 Walls will adequately limit the risk of interstitial condensation when they are designed and constructed in accordance with BS 5250 : 2011, Annexes D and G, and the relevant guidance.

8.2 For the purposes of assessing the risk of interstitial condensation, the insulation vapour resistivity may be taken as approximately $5 \text{ MN}\cdot\text{s}\cdot\text{g}^{-1}\cdot\text{m}^{-1}$.

8.3 If the products are to be used in the external walls of rooms expected to have high humidity, care must be taken to provide adequate permanent ventilation to avoid possible problems from the formation of interstitial condensation.

Surface condensation



8.4 Walls will adequately limit the risk of surface condensation when the thermal transmittance (U value) does not exceed $0.7 \text{ W}\cdot\text{m}^{-2}\cdot\text{K}^{-1}$ at any point and the junctions with other elements are designed in accordance with the guidance referred to in section 6.3.



8.5 For buildings in Scotland, constructions will be acceptable where the thermal transmittance (U value) does not exceed $1.2 \text{ W}\cdot\text{m}^{-2}\cdot\text{K}^{-1}$ at any point and the junctions with other elements are designed in accordance with the guidance referred to in BS 5250 : 2011, Annex G. Further guidance may be obtained from BRE Report BR 262 : 2002 and section 6.3 of this Certificate.

9 Behaviour in relation to fire



The products have a reaction to fire classification* of Class A1 to BS EN 13501-1 : 2007 and are, therefore defined as non-combustible under the national Building Regulations.

10 Maintenance

As the products are confined within the wall cavity and have suitable durability (see section 11), maintenance is not required.

11 Durability



The products are unaffected by the normal conditions in a wall, and is durable, rot proof, water resistant and sufficiently stable to remain effective as insulation for the life of the building.

Installation

12 General

12.1 The Certificate holder will provide on-site demonstrations on request, to ensure correct installation from the outset.

12.2 Adequate supervision of the installation should be maintained and the Certificate holder must have right of access to site to ensure correct installation.

12.3 It is recommended that the internal leaf is constructed ahead of the external leaf, as the slabs are fastened to the cavity face of the internal leaf. Slabs must not be pushed into a completed cavity.

12.4 Vertical joints in the slabs must be staggered and all joints tightly butted. Where protrusions occur in the cavity, the slabs should be carefully cut to fit.

12.5 If installation of the slabs is terminated below the highest level of the wall, the top edge of the insulation must be protected by a cavity tray and alternate perpend joints raked out, to provide adequate drainage of water from the tray.

12.6 Where required, door and window reveals should incorporate a cavity barrier/closer. It is recommended that BBA-approved cavity barriers/closers are used.

13 Procedure

13.1 A section of the internal leaf is built in the conventional manner with the first row of wall ties, at approximately 600 mm horizontal spacing, where the insulation is to begin. The wall ties should not be placed directly on the dpc. The first run of slabs should commence at least 150 mm below the dpc level to provide some edge insulation for the floor (see Figure 1).

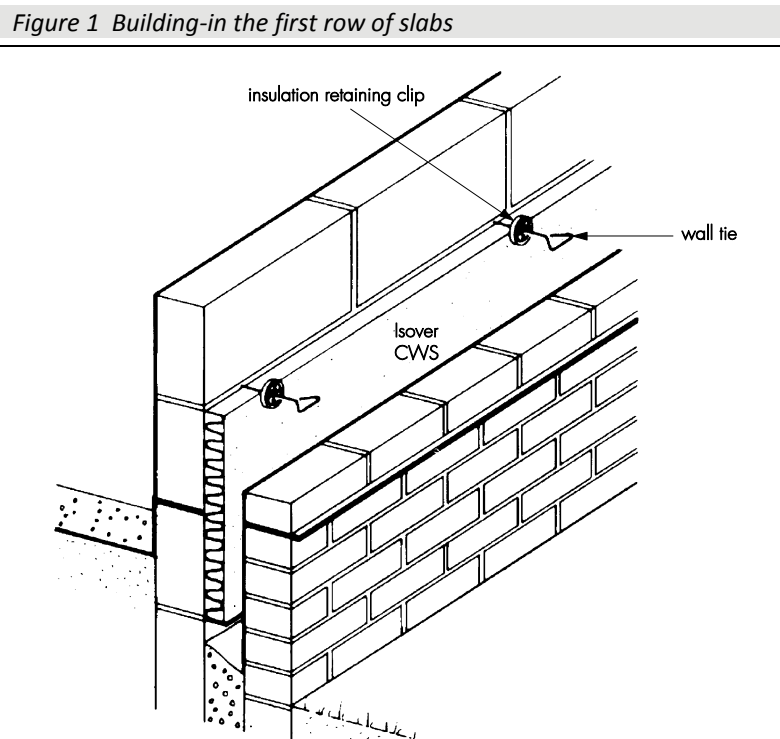

13.2 The internal leaf is then built up to a minimum height of 675 mm, with the next row of wall ties, placed at a vertical spacing of 450 mm. The ties are positioned at 450 or 900 mm horizontal spacing (depending on the thickness of the thinner leaf). Excess mortar should be cleaned from the cavity face of the internal leaf.

13.3 Slabs are compressed slightly and placed between the upper and lower wall ties to form a closely-jointed run and held in place behind insulation retaining clips. It is essential that all wall ties slope downwards towards the external leaf, ensuring the drip of the tie is located halfway across the residual cavity width to shed water away from the internal leaf (see Figure 2). It is also important that the first row of slabs are not in contact with the ground.

Figure 2 Partial fill wall tie detail

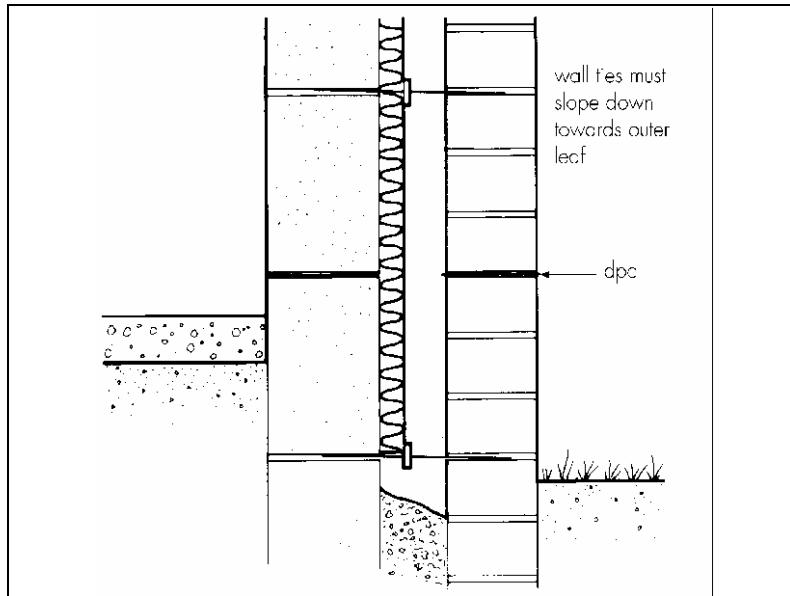

13.4 Additional ties may be required to satisfy the structural requirements of BS EN 845-1 : 2013, BS EN 1996-1-1 : 2005, BS EN 1996-2 : 2006 and BS EN 1996-3: 2006 to ensure adequate retention of slabs or cut pieces.

13.5 The external leaf is built up to the same level as the slabs.

13.6 Successive sections of wall, incorporating wall ties, are constructed and the slabs installed as work proceeds up to the required height.

13.7 Slabs should be installed to the highest level of each wall (see section 12.5).

Mortar droppings

13.8 After each section of the leading leaf is built, excess mortar should be removed from the cavity and mortar droppings cleaned from exposed edges of the installed slab before installation of the next section of slabs. Use of a cavity board or a cavity batten is recommended to protect slab edges and make cleaning easier (see Figures 3 and 4).

Figure 3 Use of a cavity board when clearing off mortar

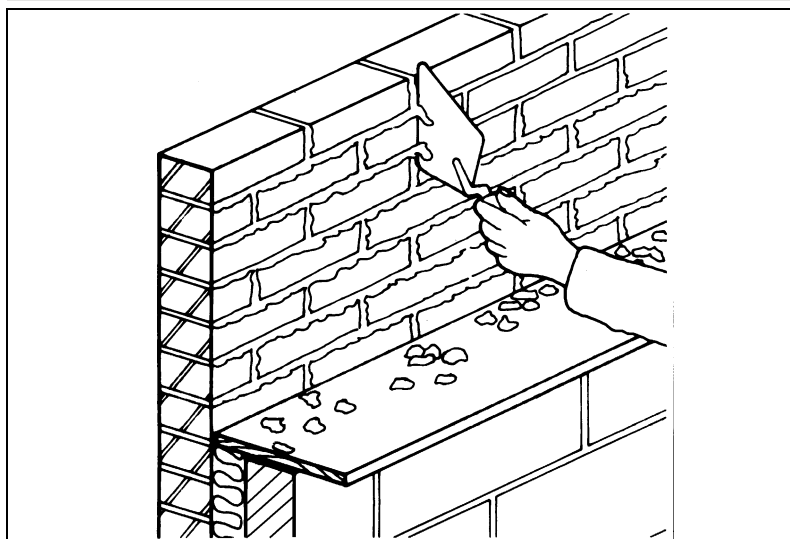
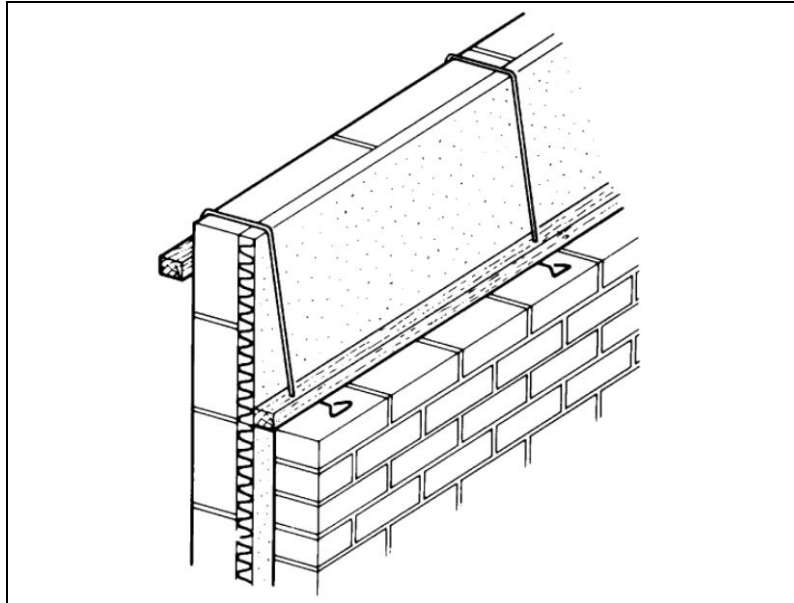

Figure 4 Use of cavity battens



Corners

13.9 Slabs should be closely butted at corners (see Figure 5) to avoid cold bridges (uncut slabs should be used for this purpose).

Figure 5 Slabs at corner detail

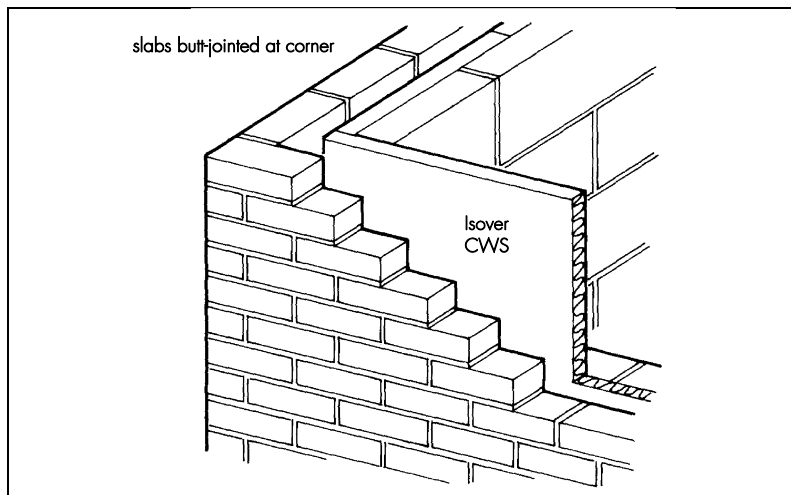

Wall openings

13.10 Where openings such as doors and windows are in close proximity, it is recommended that a continuous lintel or cavity tray is used. Individual lintels or cavity trays should have stopends and be adequately drained. Slabs should be cut to butt tightly against the cavity barrier/closer/dpc.

Cut pieces

13.11 Slabs can be cut, using a sharp knife or fine-toothed saw, to fit around windows, doors, apertures, air bricks etc. It is essential that cut pieces of slab completely fill the spaces for which they are intended and are adequately secured; gaps must not be left in the insulation (see Figure 6).

13.12 Small pieces of slab must be fitted, with the fibre layer parallel to the plane of the wall, so their faces (not their edges) are against the face of the wall.

Figure 6 Cut pieces are used to fill gaps

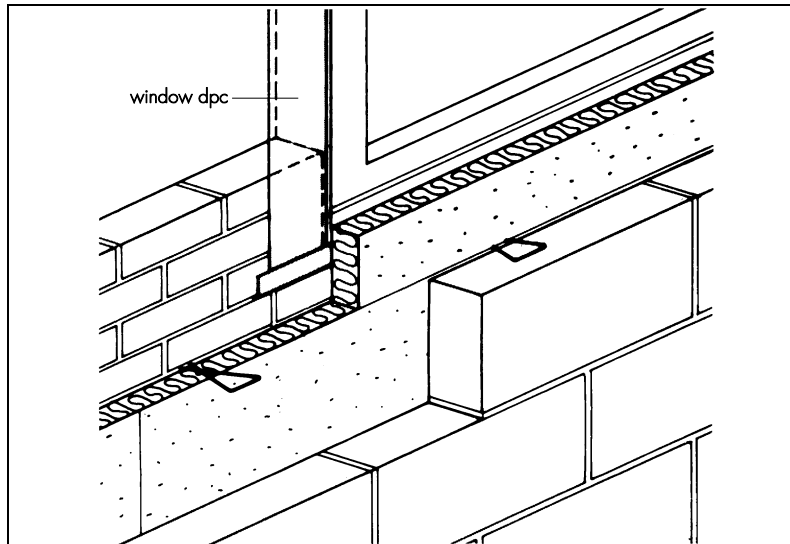

Double layers (when required)

13.13 When installing two layers of slabs, a similar procedure must be followed as for the single layer (see sections 13.1 to 13.12). The first layer is fitted against the outer masonry leaf followed by the second layer.

13.14 For cavities exceeding 150 mm, the Certificate holder's instructions must be followed regarding the type of ties to be used, and the installation should be carried out in accordance with BS EN 1996-1-2 : 2005, BS EN 1996-2 : 2006 and BS EN 1996-3 : 2006.

Protection

13.15 Exposed areas of slabs should always be covered at the end of the day's work or in driving rain.

13.16 All building involving the products, particularly interrupted work, must conform to BS EN 1996-2 : 2006, Clauses 3.2 *Acceptance, handling and storage of materials* and 3.6 *Curing and protective procedures during execution*.

Technical Investigations

14 Tests

Results of tests were assessed to determine:

- thermal conductivity
- dimensional accuracy
- water absorption
- density of air-dry slabs.

15 Investigations

15.1 Existing data on toxicity, durability and properties in relation to fire were evaluated.

15.2 A condensation risk analysis was carried out.

15.3 A series of U value calculations were carried out.

15.4 A calculation was undertaken to confirm the thermal conductivity (λ_D).

15.5 The manufacturing process was evaluated, including the methods adopted for quality control, and details were obtained of the quality and composition of the materials used.

Bibliography

BS 5250 : 2011 + A1 : 2016 *Code of practice for control of condensation in buildings*

BS 5618 : 1985 *Code of practice for thermal insulation of cavity walls (with masonry or concrete inner and outer leaves) by filling with urea-formaldehyde (UF) foam systems*

BS 8000-3 : 2001 *Workmanship on building sites — Code of practice for masonry*

BS EN 845-1 : 2013 + A1 : 2016 *Specification for ancillary components for masonry — Wall ties, tension straps, hangers and brackets*

BS EN 1996-1-1 : 2005 + A1 : 2012 *Eurocode 6 — Design of masonry structures — General rules for reinforced and unreinforced masonry structures*

NA to BS EN 1996-1-1 : 2005 + A1 : 2012 *UK National Annex to Eurocode 6 — Design of masonry structures — General rules for reinforced and unreinforced masonry structures*

BS EN 1996-1-2 : 2005 *Eurocode 6 — Design of masonry structures — General rules — Structural fire design*

NA to BS EN 1996-1-2 : 2005 *UK National Annex to Eurocode 6 — Design of masonry structures — General rules — Structural fire design*

BS EN 1996-2 : 2006 *Eurocode 6 — Design of masonry structures — Design considerations, selection of materials and execution of masonry*

NA to BS EN 1996-2 : 2006 *UK National Annex to Eurocode 6 — Design of masonry structures — Design considerations, selection of materials and execution of masonry*

BS EN 1996-3 : 2006 *Eurocode 6 — Design of masonry structures — Simplified calculation methods for unreinforced masonry structures*

NA to BS EN 1996-3 : 2006 *UK National Annex to Eurocode 6 — Design of masonry structures — Simplified calculation methods for unreinforced masonry structures*

BS EN 13162 : 2012 + A1 : 2015 *Thermal insulation products for buildings — Factory made mineral wool (MW) products — Specification*

BS EN 13501-1 : 2007 + A1 : 2009 *Fire classification of construction products and building elements — Classification using test data from reaction to fire tests*

BS EN 13914-1 : 2016 *Design, preparation and application of external rendering and internal plastering — External rendering*

BS EN ISO 6946 : 2017 *Building components and building elements — Thermal resistance and thermal transmittance — Calculation method*

ISO 9001 : 2015 *Quality management systems — Requirements*

ISO 14001 : 2015 *Environmental Management systems — Requirements with guidance for use*

PD 6697 : 2010 *Recommendations for the design of masonry structures to BS EN 1996-1-1 and BS EN 1996-2*

BRE Report BR 262 : 2002 *Thermal insulation : avoiding risks*

BRE Report BR 443 : 2006 *Conventions for U-value calculations*

16 Conditions

16.1 This Certificate:

- relates only to the products/system that is named and described on the front page
- is issued only to the company, firm, organisation or person named on the front page – no other company, firm, organisation or person may hold claim that this Certificate has been issued to them
- is valid only within the UK
- has to be read, considered and used as a whole document – it may be misleading and will be incomplete to be selective
- is copyright of the BBA
- is subject to English Law.

16.2 Publications, documents, specifications, legislation, regulations, standards and the like referenced in this Certificate are those that were current and/or deemed relevant by the BBA at the date of issue or reissue of this Certificate.

16.3 This Certificate will remain valid for an unlimited period provided that the products/system and its manufacture and/or fabrication, including all related and relevant parts and processes thereof:

- are maintained at or above the levels which have been assessed and found to be satisfactory by the BBA
- continue to be checked as and when deemed appropriate by the BBA under arrangements that it will determine
- are reviewed by the BBA as and when it considers appropriate.

16.4 The BBA has used due skill, care and diligence in preparing this Certificate, but no warranty is provided.

16.5 In issuing this Certificate the BBA is not responsible and is excluded from any liability to any company, firm, organisation or person, for any matters arising directly or indirectly from:

- the presence or absence of any patent, intellectual property or similar rights subsisting in the products/system or any other products/system
- the right of the Certificate holder to manufacture, supply, install, maintain or market the products/system
- actual installations of the products/system, including their nature, design, methods, performance, workmanship and maintenance
- any works and constructions in which the products/system is installed, including their nature, design, methods, performance, workmanship and maintenance
- any loss or damage, including personal injury, howsoever caused by the products/system, including its manufacture, supply, installation, use, maintenance and removal
- any claims by the manufacturer relating to CE marking.

16.6 Any information relating to the manufacture, supply, installation, use, maintenance and removal of this products/system which is contained or referred to in this Certificate is the minimum required to be met when the products/system is manufactured, supplied, installed, used, maintained and removed. It does not purport in any way to restate the requirements of the Health and Safety at Work etc. Act 1974, or of any other statutory, common law or other duty which may exist at the date of issue or reissue of this Certificate; nor is conformity with such information to be taken as satisfying the requirements of the 1974 Act or of any statutory, common law or other duty of care.